

Steelcase

*The Hybrid Work Tour*

# Connecting Communities

Spring 2026



# Table of Contents

01 Research & Insights

02 Applications & Featured Products

03 Sustainability

*The Hybrid Work Tour*

# Connecting Communities

Thank you for joining us at **Connecting Communities: The Hybrid Work Tour**. We hope you were inspired by the insights, spaces and technology solutions that support collaboration and innovation.

Inside this guide, you'll find the applications and products that help make hybrid work better.

# Working Together to Make Hybrid Better

Steelcase is working alongside tech leaders to provide hybrid collaboration solutions today and to prototype, iterate and evolve for tomorrow.

Working together with our partners we are striving to make space the best that it can be for supporting the new ways of working.

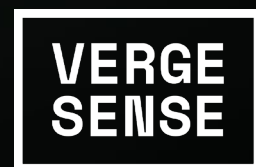

*The Hybrid Work Tour*

# Connecting Communities

Applications & Featured Products

---

# Setting Overview

The *Connecting Communities Business District* settings fit seamlessly throughout the evolving workplace, offering spaces for people to meet, share, and collaborate that spark creativity and innovation.

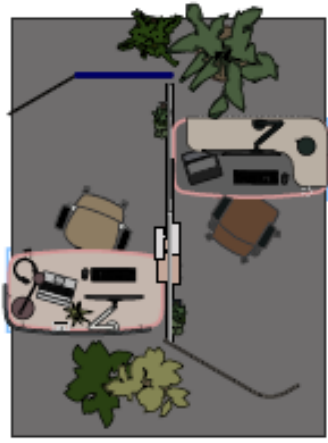

**Home Base +  
Open Touchdown**

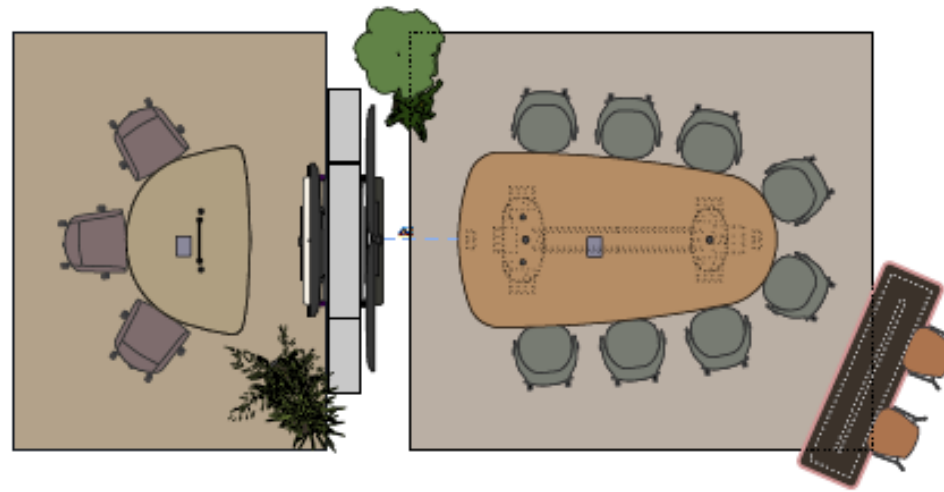

**Huddle Room**

**The Hybrid Boardroom**

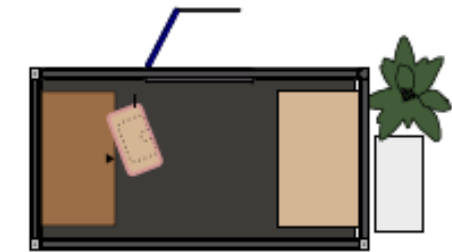

**Ocular View**

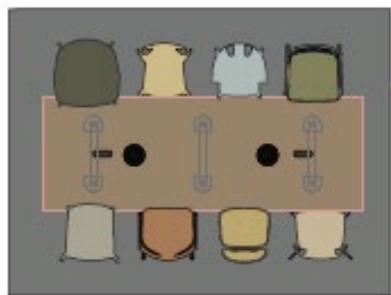

**Community Table**

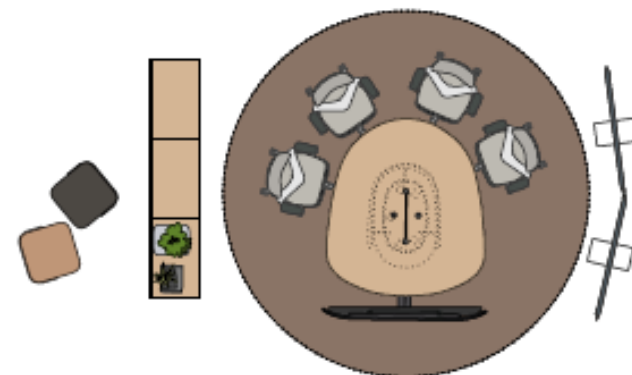

**Open Plan Collaboration**

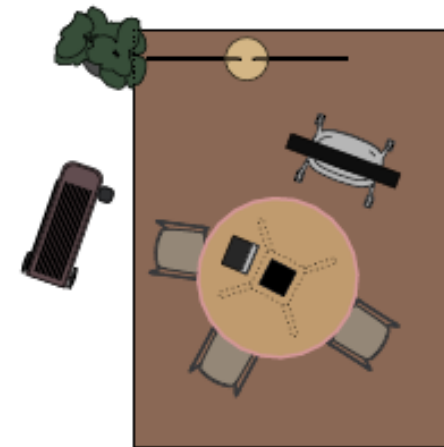

**Flexible Team Space**

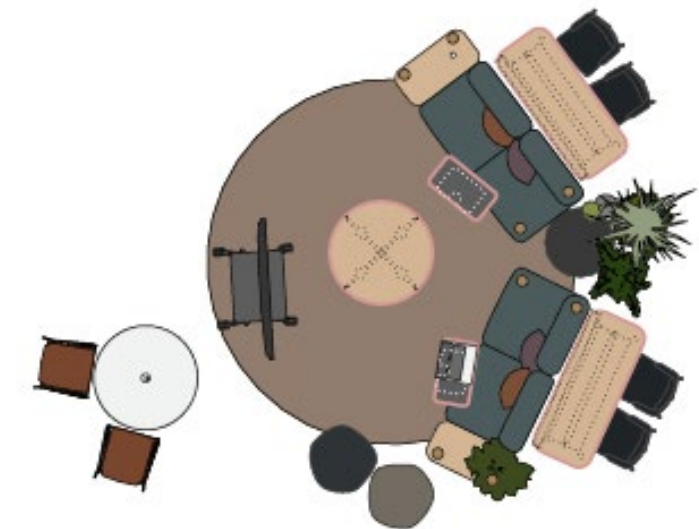

**High-Performing Ancillary Lounge**

# Technology Overview

Showcased throughout the *Connecting Communities Tour*, our strategic technology partners and their products enhance hybrid workplaces for improved collaboration and efficiency.

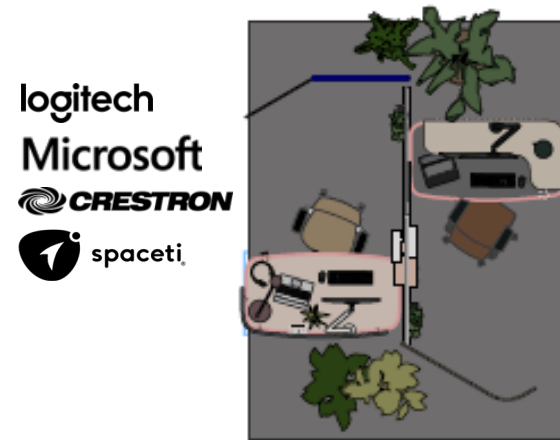

Home Base +  
Open Touchdown

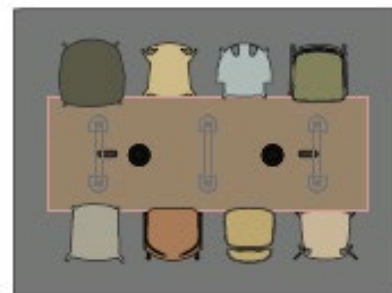

Community Table

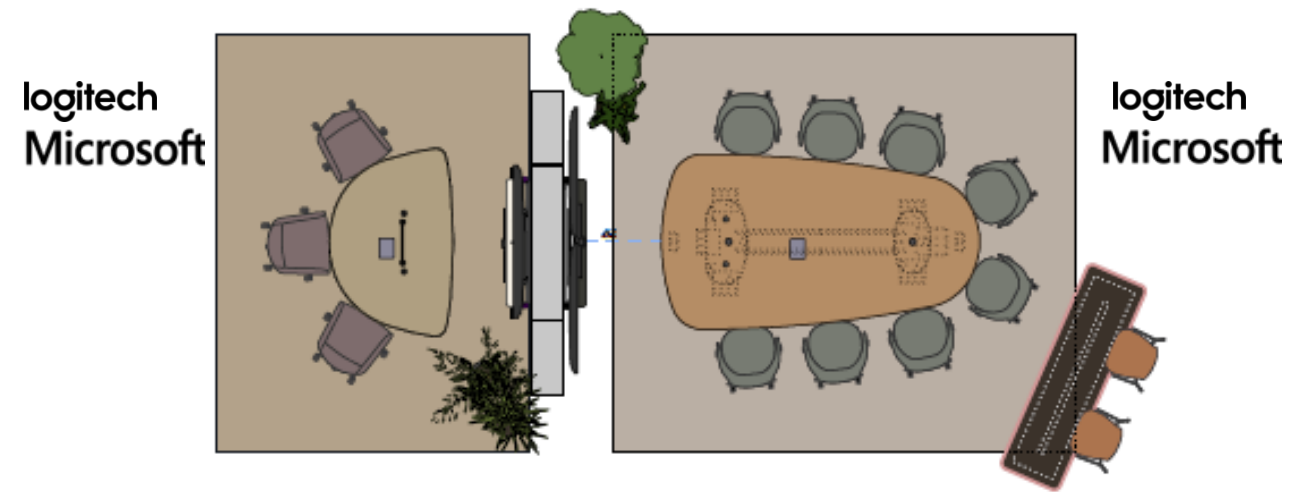

Huddle Room

The Hybrid Boardroom

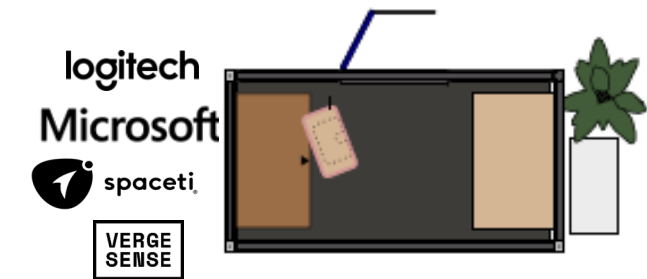

Ocular View

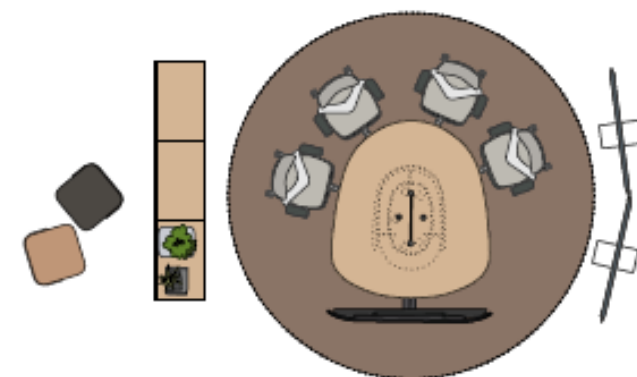

Open Plan Collaboration

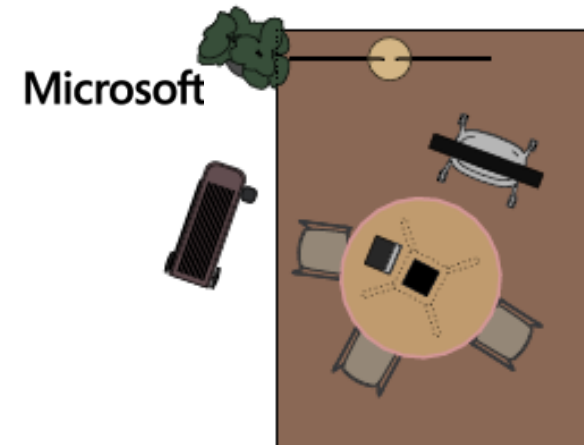

Flexible Team Space

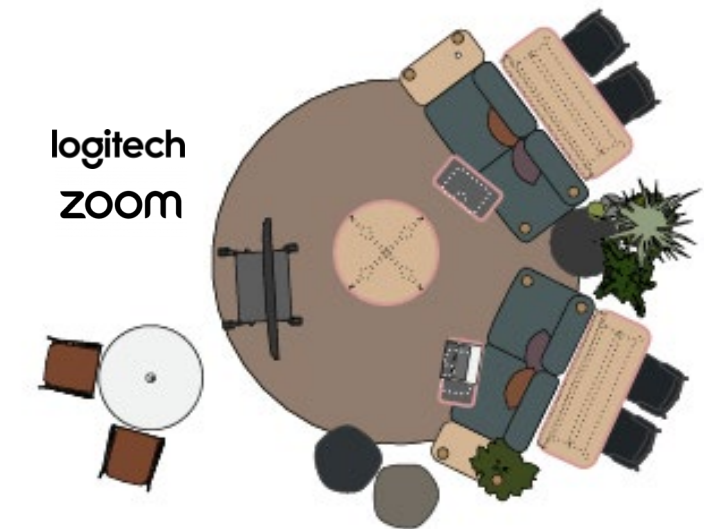

High-Performing Ancillary Lounge

# Open Touchdown



## Open Touchdown

Whether you're visiting from out of town or simply seeking a change of scenery, reservable workstations offer the flexibility to work wherever inspiration strikes, supporting both collaboration and deep focus with acoustic and visual privacy. Sustainability is also built into every detail, from FSC-certified wood in Migration Pro to increased recycled content in Steelcase's task seating portfolio, helping you work better while supporting a net-zero future.

### Featured Products

1. Steelcase Answer Fence
2. Studio b Slotted Screen
3. Steelcase Series 2 Task Chair
4. Steelcase Migration Pro HAD
5. Steelcase Dash Mini LED Light
6. Steelcase CF Max Single Monitor Arm
7. Steelcase Soffio Screen
8. Steelcase Flex Freestanding Screen
9. Studio b Slotted Screen Accessories and Shelves
10. Mooi Canvas Area Rug
11. Logitech Personal Workspace Solutions

### Not Pictured

1. Steelcase CF Max Single Monitor Arm
2. Steelcase Eclipse Light
3. Steelcase Powerstrip Intro
4. Crestron Desk Q
5. Microsoft Surface Laptop



# Open Touchdown



## Migration Pro HAD

Steelcase  
Chalk base, Clay top and edgeband



## CF Max Single Monitor Arm

Steelcase  
Pearl Snow



## Dash Mini LED Light

Steelcase  
Smokey Plum



## Powerstrip Intro

Steelcase  
Arctic White



## Logidock Flex

Logitech

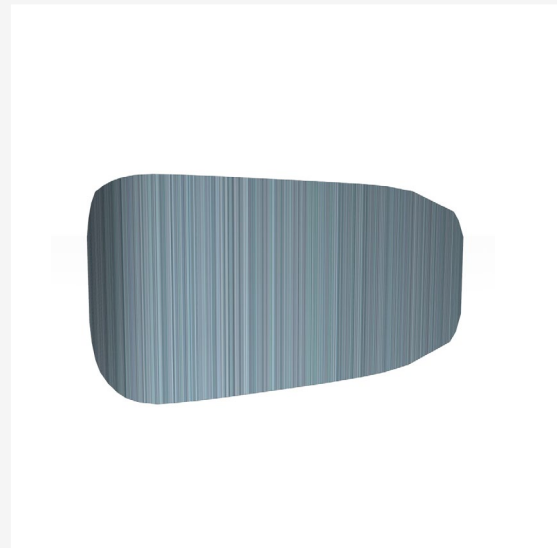

## Soffio Screen

Steelcase  
Designtex Billiard – Storm Cloud



## Flex Freestanding Screen

Steelcase  
Designtex Digital Design Studio  
Ribbon Pattern, custom colors

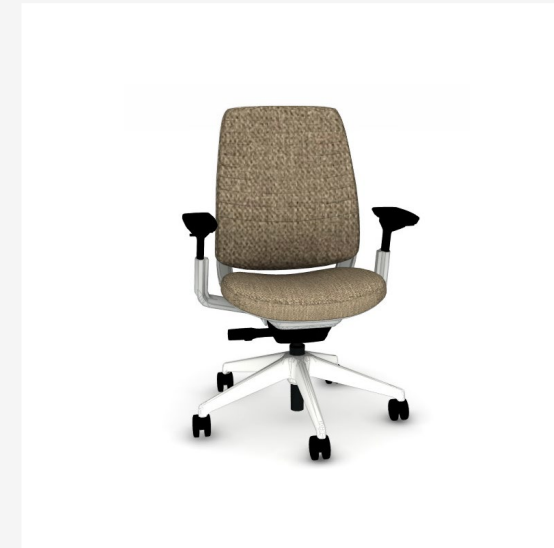

## Series 2 Task Chair

Steelcase  
Designtex Grenoble Crypton - Wheat,  
Seagull, Near Black

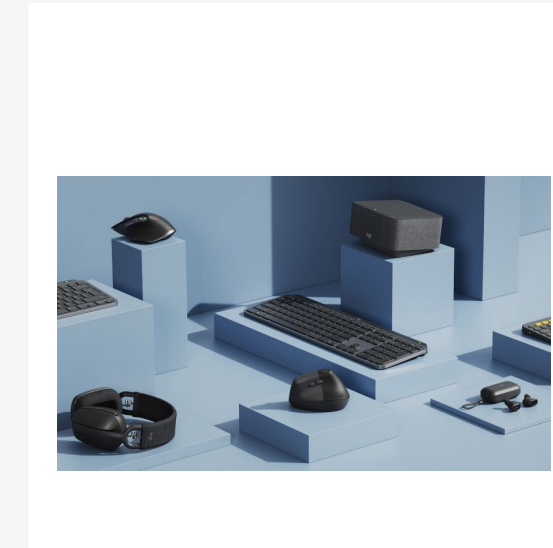

## Personal Workspace Solutions

Logitech  
Mouse, Keyboard, Headset, Webcam

# Home Base



## Home Base

This thoughtfully designed workstation solves for the overexposed bench in the open plan, offering exceptional visual and acoustic privacy. Steelcase Flex Personal Spaces wraps creates a comforting setting that helps you focus without distractions. The Steelcase Eclipse Light ensures you're perfectly lit for Teams or Zoom calls, right from your desk. With built-in power access throughout, staying charged and connected all day is effortless.

### Featured Products

1. Steelcase Answer Fence
2. Studio b Slotted Screen
3. Steelcase Gesture Task Chair
4. Steelcase Migration Pro HAD
5. Steelcase Flex 90 Privacy Wrap
6. Steelcase Flex 120 Back Privacy Wrap
7. Moooi Canvas Area Rug
8. Studio b Slotted Screen Accessories and Shelves
9. Logitech Personal Workspace Solutions
10. Microsoft Surface Pro + Flex Keyboard

### Not Pictured

1. Steelcase CF Max Single Monitor Arm
2. Steelcase Eclipse Light
3. Steelcase Powerstrip Plus
4. Logitech Logidock Flex



# Home Base



**Migration Pro HAD**  
Steelcase  
Chalk base, Satin Stone top



**CF Max Single Monitor Arm**  
Steelcase  
Black

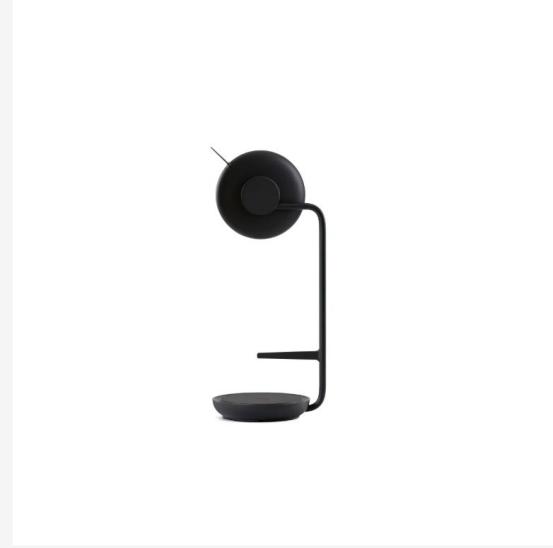

**Eclipse Light**  
Steelcase  
Black



**Powerstrip Plus**  
Steelcase  
Merle

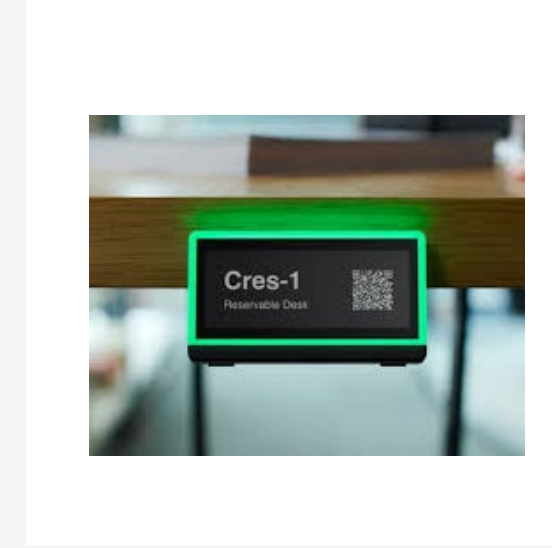

**Desk Q**  
Creston (w/ Spaceti Integration)



**Flex 120 Back Privacy Wrap**  
Steelcase  
Sand Wrap Knit



**Flex 90 Privacy Wrap**  
Steelcase  
Sand Wrap Knit



**Gesture Task Chair**  
Steelcase  
Café – Chocolate Mousse, Sterling  
Dark Solid



**Personal Workspace Solutions**  
Logitech  
Mouse, Keyboard, Headset, Webcam

# Home Base / Open Touchdown



## Answer Fence

*Steelcase  
Chalk*



## Slotted Screen

*Studio b  
Chalk, White Washed Birchply  
Laminate*



## Slotted Screen Accessories

*Studio b  
Whiteboard, Baltic*



## Slotted Screen Shelves

*Studio b  
Sandstone, Chalk*

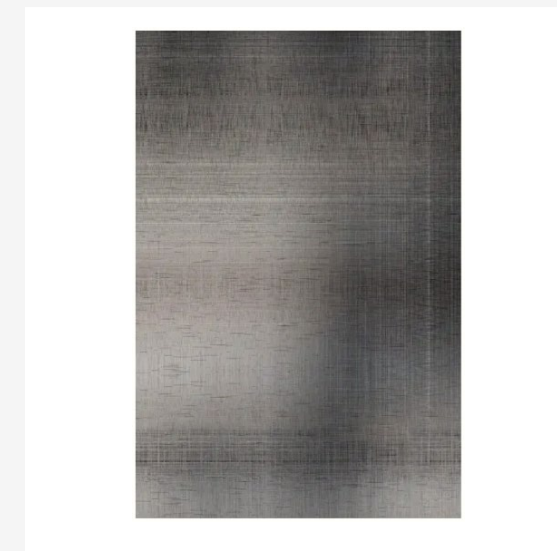

## Canvas Area Rug

*Moooi  
Ombre*

# The Community Table



## The Community Table

This inviting space encourages coworkers to gather for coffee chats, lunch breaks, or a quick pause before a meeting, creating natural opportunities to build relationships. It's a visible, welcoming spot in the workplace where people can connect, catch up, or send a quick email. Designed to support wellbeing, it also offers a moment of calm in the middle of a busy day. Short breaks here help reduce stress and improve focus, making it a valuable destination for both connection and clarity.

### Featured Products

1. Steelcase Verlay Table
2. West Elm Slope Chair
3. Viccarbe Quadra Chair
4. Moooi Nut Dining Chair
5. Coalesse Wrapp Chair
6. West Elm Fulton Chair
7. Coalesse Montara650 Chair
8. Coalesse Enea Lottus Chair
9. Enea Altzo943 Chair

### Not Pictured

1. Steelcase Flex Mobile Power



# The Community Table



## Verlay Rectangular Table

Steelcase  
Ashwood Oak, Night Bronze,  
Mushroom Inset



## Wrapp Chair

Coalesse  
Designtex Hint - Almond



## Enea Altzo943 Chair

Coalesse  
Olive shell with Natural Oak legs



## Enea Lottus Chair

Coalesse  
Sandstone Shell with Sand frame



## Montara650 Chair

Coalesse  
Gray Oak and Graphite Matte



## Fulton Chair

West Elm  
Designtex Checker - Tomatillo



## Slope Chair

West Elm  
SoftNext - Greystone, Mocha Frame



## Nut Dining Chair

Moooi  
Oak Cinnamon frame, Divina3236

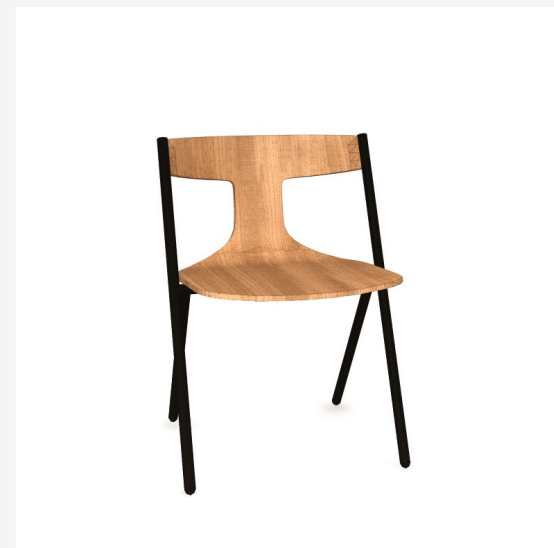

## Quadra Chair

Viccarbe  
Black RAL 9005, Matt Oak



## Flex Mobile Power

Steelcase  
Black

\*Note – Available in late 2025 - early 2026

# The Huddle Room



## The Huddle Room

Huddle rooms are among the most popular spaces for teams of 3–5 to collaborate quickly and effectively. With Microsoft Teams Room integration, meetings are easy to schedule, locate, and launch. The Ocular curved table ensures everyone is clearly seen and heard, while integrated surface power keeps devices charged and participants engaged. Designed to flex with your space, the Ocular Frame features a fabric finish that adds sound absorption for a quieter, more comfortable environment.

### Featured Products

1. Steelcase Ocular Coupe3 Table
2. Steelcase Ocular Frame
3. Coalesse Marien152 Chair
4. Moooi Morning Rectangle Rug
5. Logitech Meetup 2
6. Logitech Tap Controller

### Not Pictured

1. Steelcase Ocular Cable Pods



# The Huddle Room



## Ocular Frame

Steelcase  
Chalk Paint + Laminate  
Designtex Dovetail - Dune

*\*Note – Available in early 2026*



## Ocular Coupe3 Table

Steelcase  
Ashwood Beige, Light Heather Grey



## Marien152 Chair

Coalesse  
Burnished Bronze, Designtex  
MicroTweed - Fig

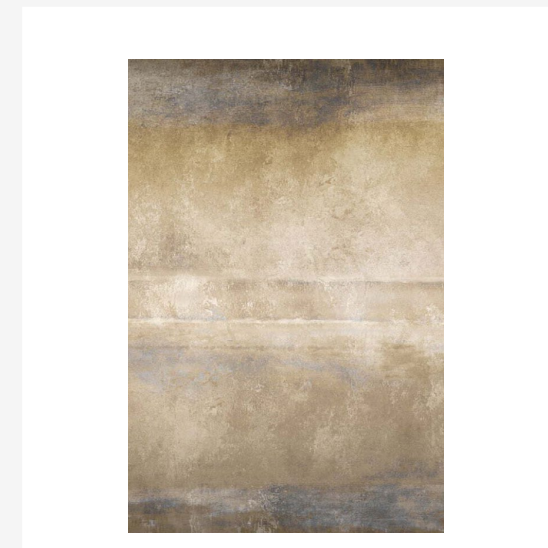

## Morning Rectangle Rug

Moooi  
Quiet Collection, Color: Nude



## Meetup 2

Logitech



## Tap Controller

Logitech

# The Hybrid Boardroom



## The Hybrid Boardroom

In the Hybrid Boardroom, thoughtful table shapes, cable routing, and camera positioning ensures everyone is seen and heard, providing better experiences for people to meet, share, and collaborate. The Ocular Frame and Ocular Sightline solutions make hybrid meetings effortless with streamlined tech integration. Whether hosting single, dual, or ultra-wide monitors, Ocular Frame ensures great engagement with remote meeting participants, shared content, and meeting chats and reactions.

### Featured Products

1. Steelcase Ocular Sightline Table
2. Steelcase Ocular Frame
3. Coalesse Massaud Conference Chair
4. Coalesse Potrero415 Table
5. Coalesse Montara650 Stool
6. Moooi Crisp Dawn Awakens Rug
7. Logitech Rallybar Mini
8. Logitech Tap Controller

### Not Pictured

1. Steelcase Ocular Cable Pods
2. Logitech Sight



# The Hybrid Boardroom



## Ocular Frame

Steelcase  
Washed Walnut FC/OP, Merle

\*Note – Available in early 2026



## Ocular Sightline Table

Steelcase  
Washed Walnut FC/OP, Dark Heather  
Grey



## Massaud Conference Chair

Coalesse  
Designtex Everywhere Texture –  
Soapstone, Tour – Trinket, Low gloss  
Black base



## Rallybar Mini

Logitech



## Sight

Logitech



## Montara650 Stool

Coalesse  
Café Leather, color Chai, Graphite  
Matte

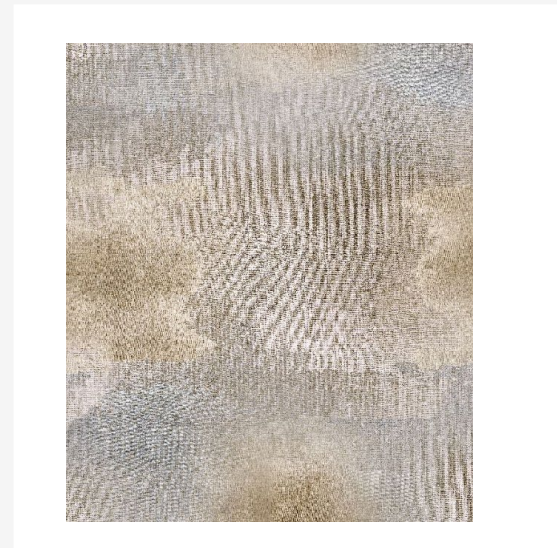

## Crisp Dawn Awakens Rug

Moooli  
Earth Collection, color: Bright



## Potrero415 Table

Coalesse  
Dark Cork Laminate, Night Bronze,  
Clay Rings



## Tap Controller

Logitech

# The Flexible Team Space



## The Flexible Team Space

This open, collaborative space is designed for spontaneous brainstorming and quick team huddles. With the Microsoft Surface Hub, teammates can easily share screens and whiteboard digitally with remote teammates. The standing-height table and stools support active postures, encouraging movement and engagement. Whether you're sketching out ideas or solving problems on the spot, this space adapts to your work style and keeps collaboration flowing.

### Featured Products

1. Coalesse Portrero415 Table
2. Orangebox Cubb Barstool
3. Steelcase Flex Markerboards
4. Steelcase Flex Cart
5. Steelcase Flex Stand
6. Moooi Rugged/Refined Rectangle
7. Microsoft Surface Hub 3 and Steelcase Roam Mobile Cart



# The Flexible Team Space



**Steelcase Roam +  
Microsoft Surface Hub**

*Steelcase Roam Cart, Microsoft 50”  
Surface Hub 3*



**Potrero415 Table**

*Coalesse  
Aged Ash Laminate, Night Bronze,  
Copper Ring*



**Cubb Barstool**

*Orangebox  
Desigtex Tweedy Twill – Haystack,  
Heather – Brown Blue, Burnished  
Bronze*



**Flex Cart + Markerboards**

*Steelcase  
Smokey Plum*



**Flex Stand**

*Steelcase  
Merle, Baltic Birch*

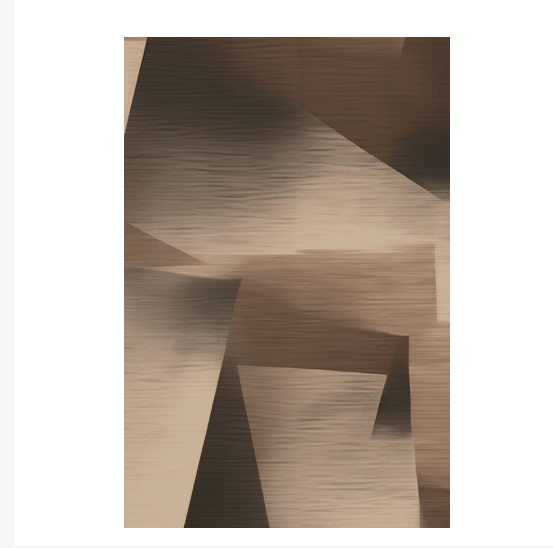

**Rugged/Refined Rectangle**

*Moooi  
Gensler Collection, color: Day*

# Open Plan Collaboration



## Open Plan Collaboration

The Ocular Coupe Tower is a versatile, collaboration-ready solution that seamlessly blends technology and furniture in huddle spaces. With integrated power, cable management, and a display and camera mount, it supports on-demand teamwork in any setting. An easy-access tech panel keeps power organized, simplifying housing, routing, and mounting. As hybrid work continues to grow, WorkValet is a necessity by offering secure, convenient storage for personal belongings for movement throughout the business district.

### Featured Products

1. Steelcase Ocular Coupe Tower
2. Steelcase Karman Stool
3. Steelcase WorkValet
4. Viccarbe Season Pouf
5. Moooi Tranquility Day Rug
6. Snowsound PLI Oversized + Stand
7. Microsoft Surface Laptop

### Not Pictured

1. Steelcase Ocular Cable Pods



# Open Plan Collaboration



**Coupe Standing Tower**

*Steelcase  
Clear Oak, Dark Heather Grey, Merle*



**Karman Stool**

*Steelcase  
Seagull, Intermix Opaque - Seagull*

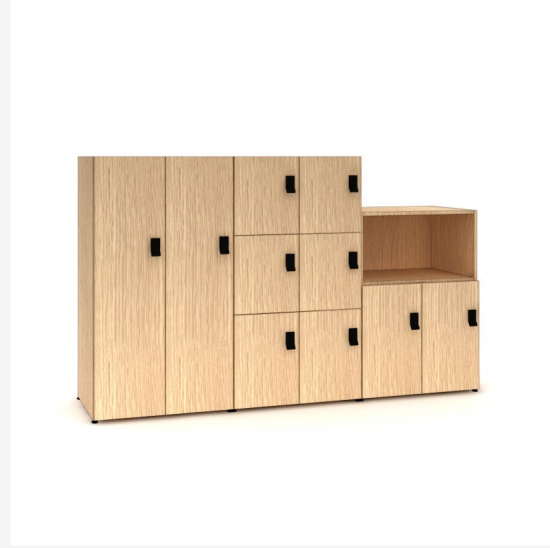

**WorkValet**

*Steelcase  
Clear Oak*



**PLI Oversized + Stand**

*Snowsound  
Carcoal Grey, Matte White*



**Season Pouf**

*Viccarbe  
Designtex Everywhere Texture -  
Ember, Designtex Pause - Forge*



**Tranquility Day Rug**

*Moooi  
Gensler Collection*

# Ocular View



## Ocular View

Co-developed by Steelcase and Logitech, Ocular View is an immersive, realistic and personal meeting experience that makes you feel like you're together, even if you're miles apart. With natural eye contact, life-size presence, and distraction-free design, virtual meetings now feel more human. In a time when 87% of employees feel disengaged, this solution supports wellbeing by making remote collaboration feel truly connected.

### Featured Products

1. Steelcase Ocular View
2. Coalesse Circa Lounge
3. Languitas Personal Table
4. Steelcase Everwall
5. Steelcase Victor2 Mobile Unit
6. Moooi Canvas Area Rug

### Not Pictured

1. Steelcase Flex Freestanding Screen
2. Logitech Tap Controller
3. Logitech Rallyplus System
4. Spaceti Environmental Sensor
5. VergeSense Occupancy Sensor

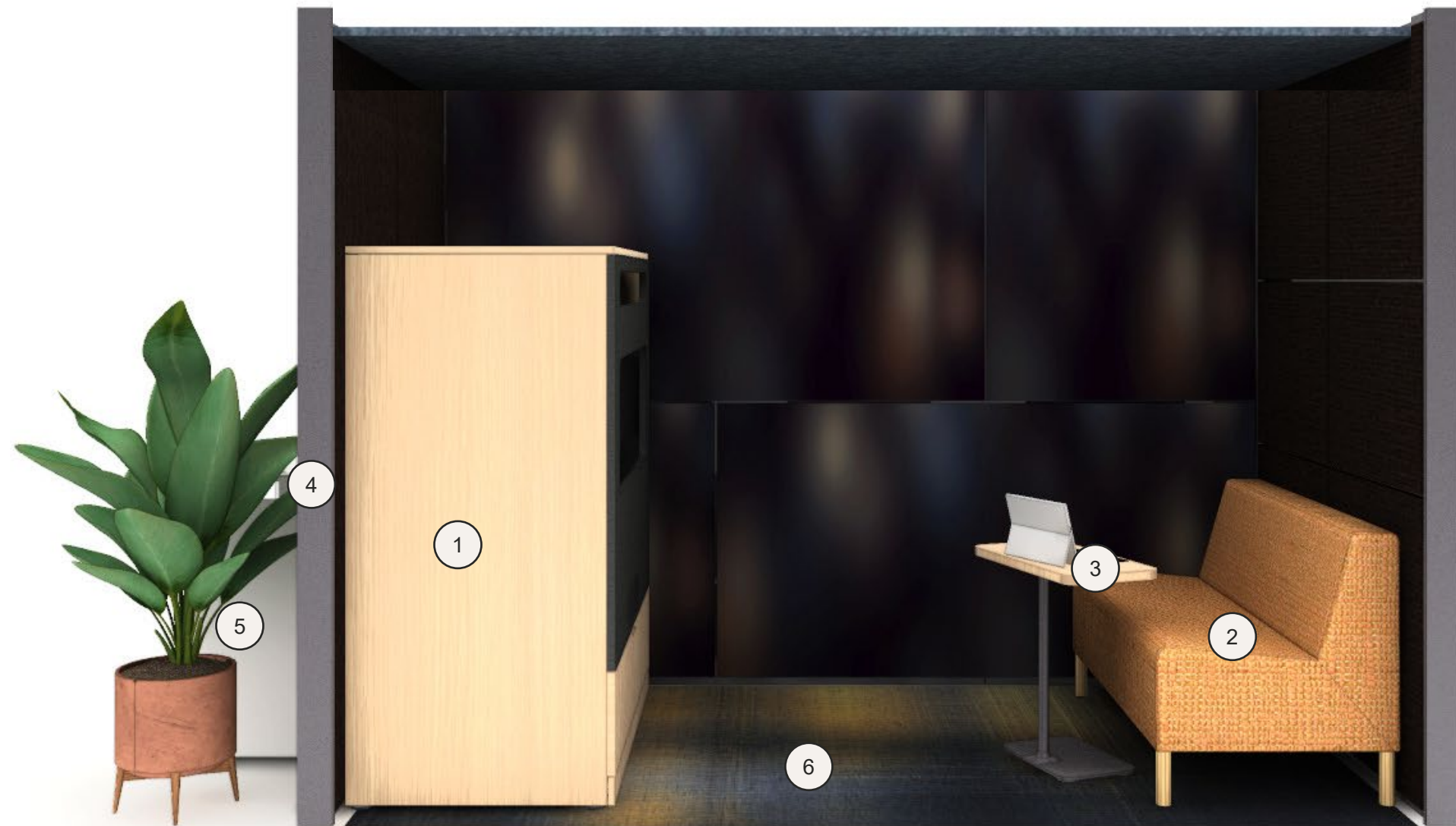

# Ocular View



## Circa Lounge

Coalesse  
DesignTex Gather - Tan



## Ocular View

Steelcase  
Clear Oak



## Lagunitas Personal Table

Coalesse  
Clear Oak, Merle base



## Everwall

Steelcase  
Clear Oak Laminate, Fabrics: DesignTex  
Gamut Unfinished - Carbon, Hush - Onyx,  
DDS - Digital Dawn 2, Arne - Flax



## Tap Controller

Logitech



## Rallyplus System

Logitech  
Camera, Mic, Speaker



## Victor2 Mobile Unit

Steelcase  
Arctic White, Chalk Laminate



## Flex Freestanding Screen

Steelcase  
DesignTex Gamut - Carbon and  
Cobblestone

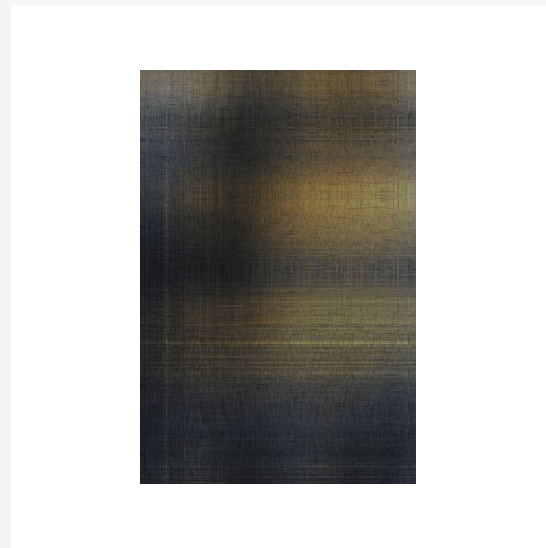

## Canvas Area Rug

Moooi  
Shantung



## Environmental Sensor

Spaceti



## Occupancy Sensor

VergeSense

# High-Performing Ancillary Lounge



## High-Performing Ancillary Lounge

This lounge setting designed to spark natural conversation and effortless collaboration. This space encourages participation, making it ideal for both casual chats and informative meetings. The space supports mixed postures, whether lounging, sitting upright, or standing due to thoughtfully placed ottomans, tables, and accessible power. For added flexibility, the Rally Board 65 Cart allows the camera to be positioned above or below, enabling meetings and whiteboarding wherever inspiration strikes.

### Featured Products

1. Coalesse Ensemble
2. Coalesse Lagunitas Personal Table
3. Bassline Coffee Table
4. Steelcase Alight Ottoman
5. Steelcase Thread Hub
6. Viccarbe Burin Table
7. Coalesse Montara650 Stool
8. Steelcase Flex Table
9. Coalesse Marien152 Stool
10. Moooi Aqua Floral Round Rug
11. Logitech Rally Board 65"
12. Microsoft Surface Pro + Flex Keyboard

### Not Pictured

1. Orangebox Cubb Occasional Table



# High-Performing Ancillary Lounge



**Montara650 Stool**

Coalesse  
Café Leather, color Chai, Graphite  
Matte



**Burin Table**

Viccarbe  
Taupe, White



**Flex Table**

Steelcase  
Clear Oak Laminate, Merle Paint



**Marien152 Stool**

Coalesse  
DesignTex In The Cloud – Maritime,  
Night Bronze



**Bassline Coffee Table**

Steelcase  
Clear Oak, Night Bronze



**Lagunitas Personal Table**

Coalesse  
Satin Stone Laminate, Night Bronze



**Ensemble Lounge + Tables**

Coalesse  
Clear Oak Laminate, Merle Paint,  
DesignTex FOMO - Fir



**Alight Ottoman**

Steelcase  
DesignTex Rocket – Osprey,  
DesignTex Iota - Currant



**Thread Hub**

Steelcase  
Merle

# High-Performing Ancillary Lounge



**Aqua Floral Round Rug**

*Moooi  
Green House Collection, color: Jasmine*



**Cubb Occasional Table**

*Orangebox  
Blackwood laminate top, Natural  
(Raw) oak legs*



**Rallyboard 65**

*Logitech*

*The Hybrid Work Tour*

# Connecting Communities

Research & Insights

---

# Unprecedented Change & Uncertainty



**Work has changed more in the  
past five years than in generations.**

Change fatigue contributes  
to low employee engagement  
and falling productivity growth.

New patterns  
of work need  
*new patterns  
of space*

## Forces Changing Work

Living on Screen



Sustainability Mindset



AI Supercycle

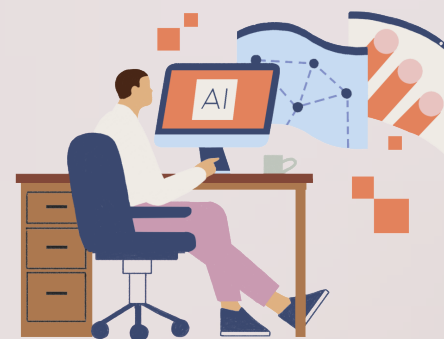

Wellbeing Urgency



## We're in more virtual meetings than ever before



56%

Include remote participants

44%

Fully in-person

*Steelcase Global Research*

## People choose convenience over connection

50% of employees do not leave their desks for video calls. Here's why:

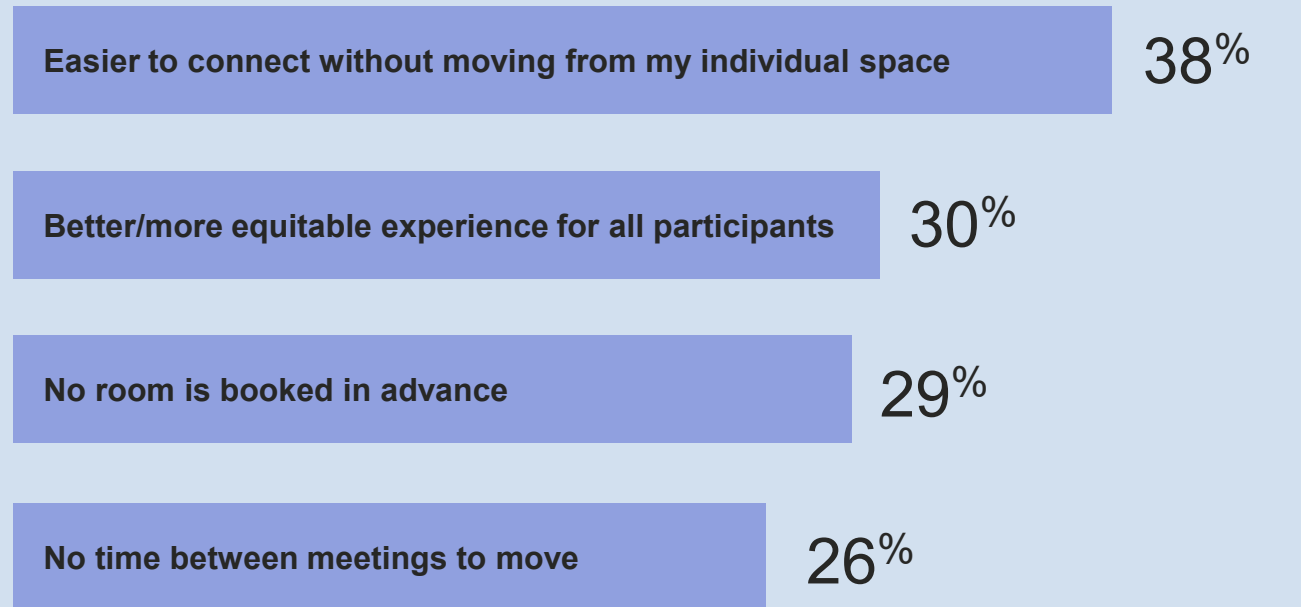

*Steelcase Leader Research*

## Macro Shift

# Living on Screen

Screen-based interactions have overtaken in-person communications.

## Employees are leading the adoption of AI at work



Employees

# 75%

Of global knowledge workers use AI, nearly doubling in six months

Leaders

# 60%

Of leaders worry their organization lacks a vision to implement AI

*Steelcase Global Research*

## AI skills are now “must-haves”

66% of leaders would not hire someone without AI skills

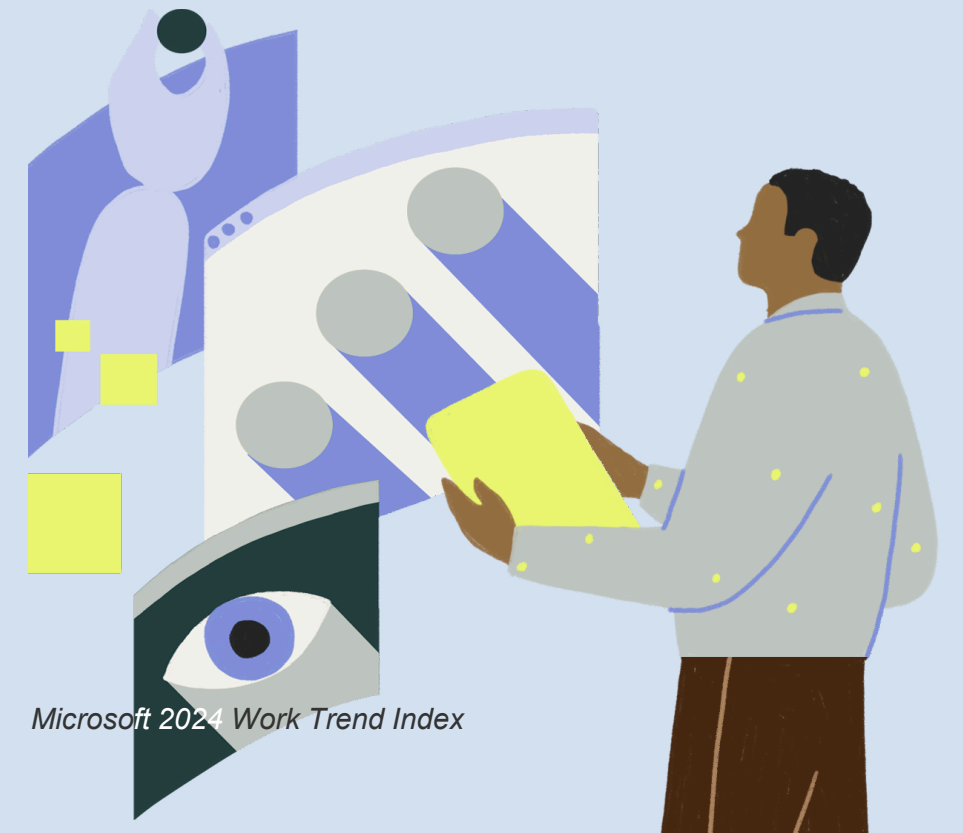

*Microsoft 2024 Work Trend Index*

Macro Shift

# AI Supercycle

Employees are rapidly adopting AI and leaders know they need to leverage it more.

The number of companies setting science-based carbon reduction targets doubled in one year

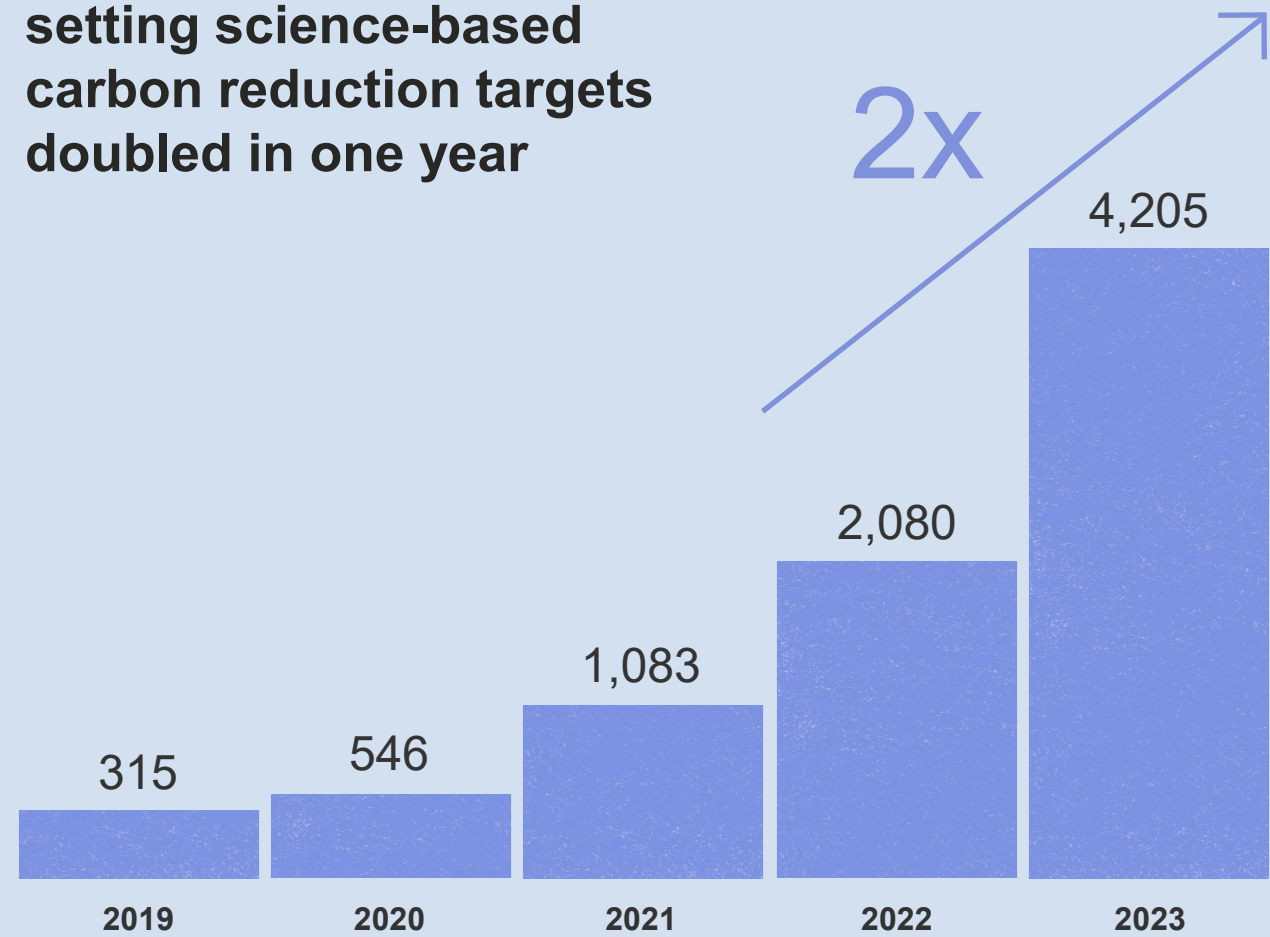

Science Based Targets initiatives (SBTi)

Workplaces designed with a range of settings are easier to change and more sustainable

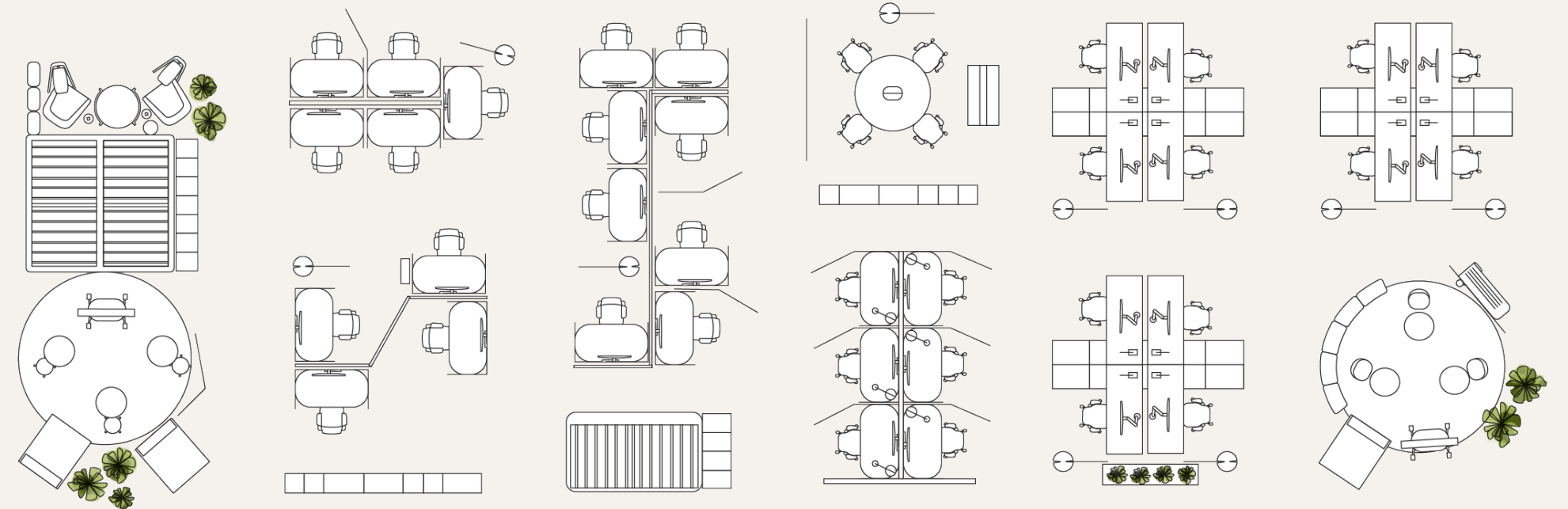

Macro Shift

# Sustainability Mindset

Organizations prioritizing sustainability need flexible and adaptable workplaces to help achieve their goals.

## Many employees are not thriving



All Employees

# 66%

Of employees are not thriving

Millennials & Gen Z

# 69%

Of employees under 35 are not thriving

*Gallup State of the Global Workplace*

## The number of U.S. employees who believe their employer cares about their wellbeing keeps dropping

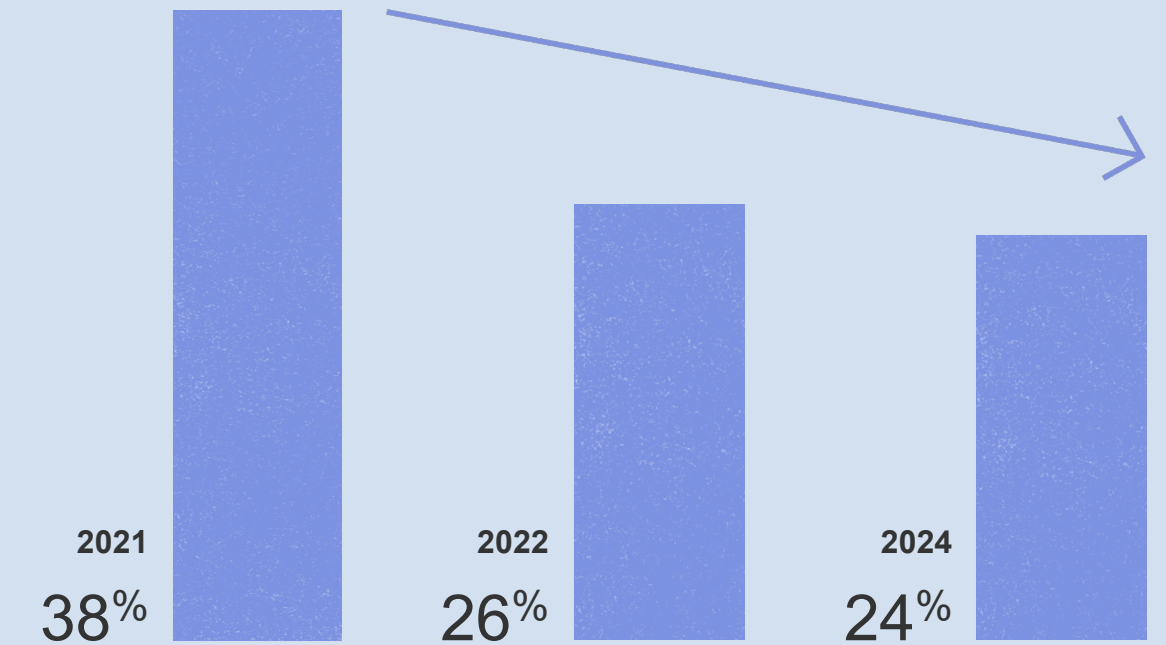

*Steelcase Employee Research*

## Macro Shift

# Wellbeing Urgency

Employees have new expectations that organizations will take action to support their mental health.



## Business District

A diverse range of shared spaces where people come together to meet, share, brainstorm and collaborate — an environment that sparks creativity and innovation.



# Applying Community-Based Design Principles

Before & After

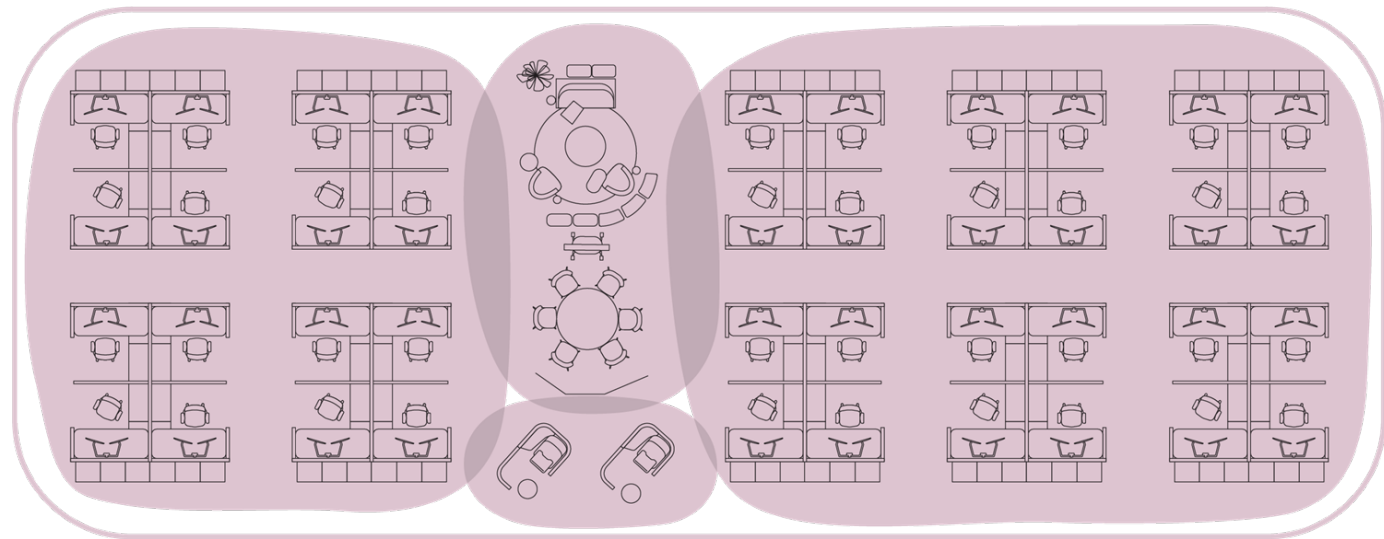

**From:**

Single-purpose areas  
One-size fits all  
Repeating patterns

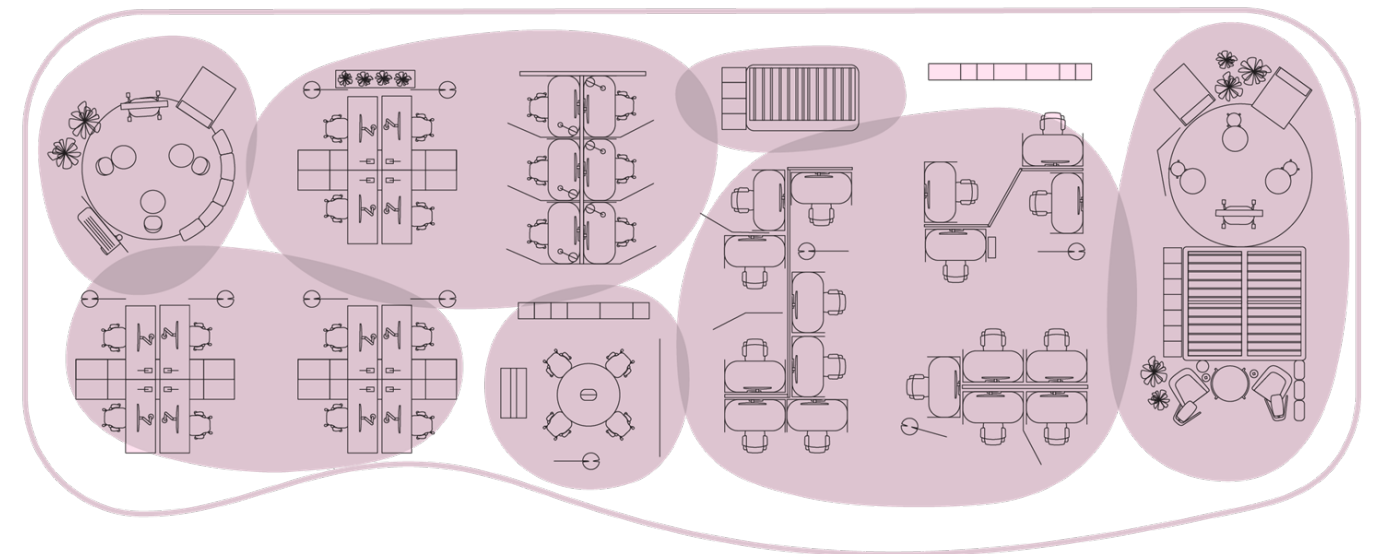

**To:**

Purposefully mixed-use  
Diversity of spaces  
Offers choice & control  
Responds to unique needs of the organization

# Reinventing Five Essential Spaces

Consider the issues and explore solutions within the applications on the *Connecting Communities Tour*

## The Underused Conference Room

Transform a single large conference room into four spaces where people can collaborate, focus and rejuvenate.

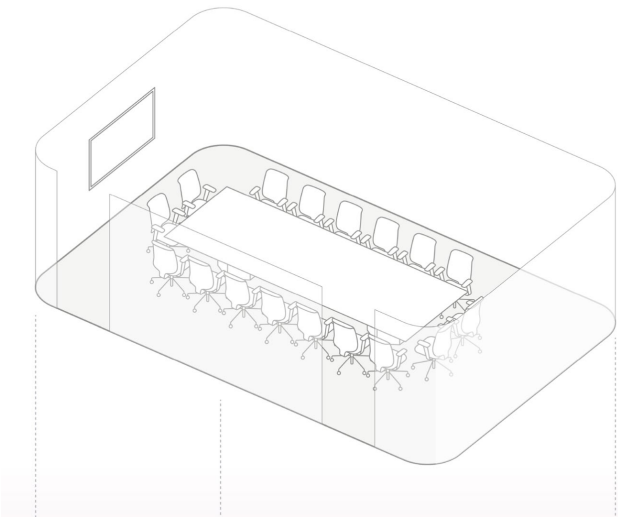

**Before**  
A traditional, large conference room is often unused or underutilized

## The Overexposed Bench

Benching, where people face one another, creates visual distractions and provides little noise mitigation.

Reorient desks and add a range of privacy solutions to control nearby distractions.

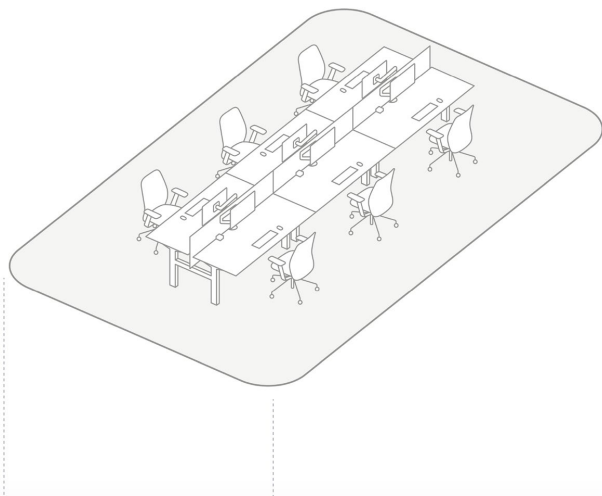

**Before**  
Rows of benching, with people facing one another, create visual distractions and provide little noise mitigation.

## The Low-Performance Lounge

Beautiful spaces too often sit empty because they don't help people get work done.

Design for privacy, posture, proximity and presence to create desirable, high-performing spaces.

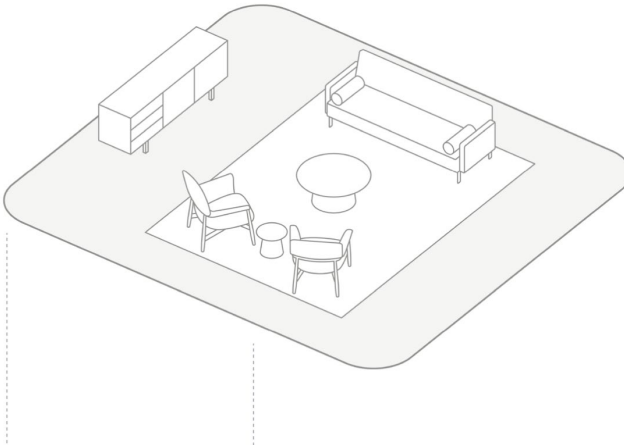

**Before**  
Lounge spaces are often underutilized because furnishings lack key performance elements.

## The Inflexible Meeting Room

Typical conference rooms can limit how teams collaborate and inhibit creative problem-solving.

Add mobile furniture, technology and light-weight markerboards to encourage in-person and remote participants to engage and adapt the space to their needs.

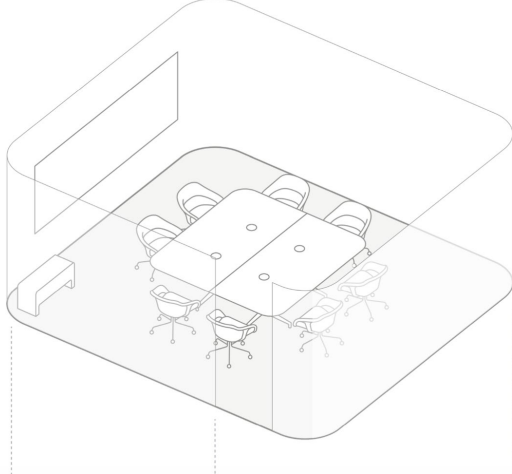

**Before**  
Typical conference rooms can limit how teams collaborate and inhibit creative problem-solving.

## The Typical Team Space

A neighborhood focused on uniformity doesn't consider the ebb and flow of solo to group work throughout the day.

Replace single-purpose areas and monotonous patterns with mixed-use spaces that give people access to a range of experiences for different tasks.

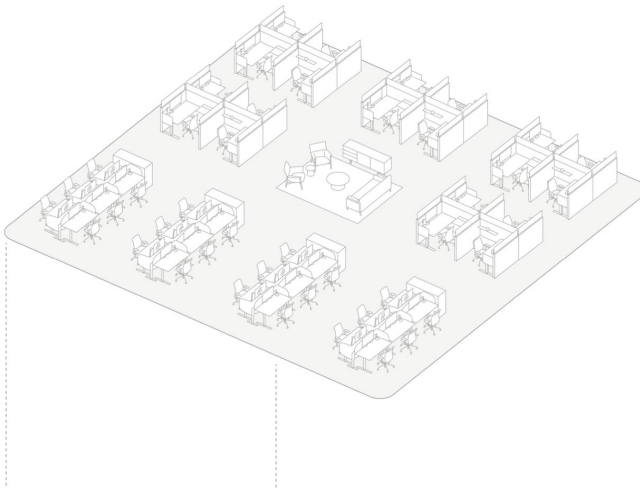

**Before**  
A neighborhood focused on uniformity doesn't consider the ebb and flow of work in which people must toggle between working alone or together.

*The Hybrid Work Tour*

# Connecting Communities

Sustainability

---

Better Futures — Planet

We're doing better for the planet by *transforming our business and committing to a net-zero future* to build a more sustainable and resilient world.

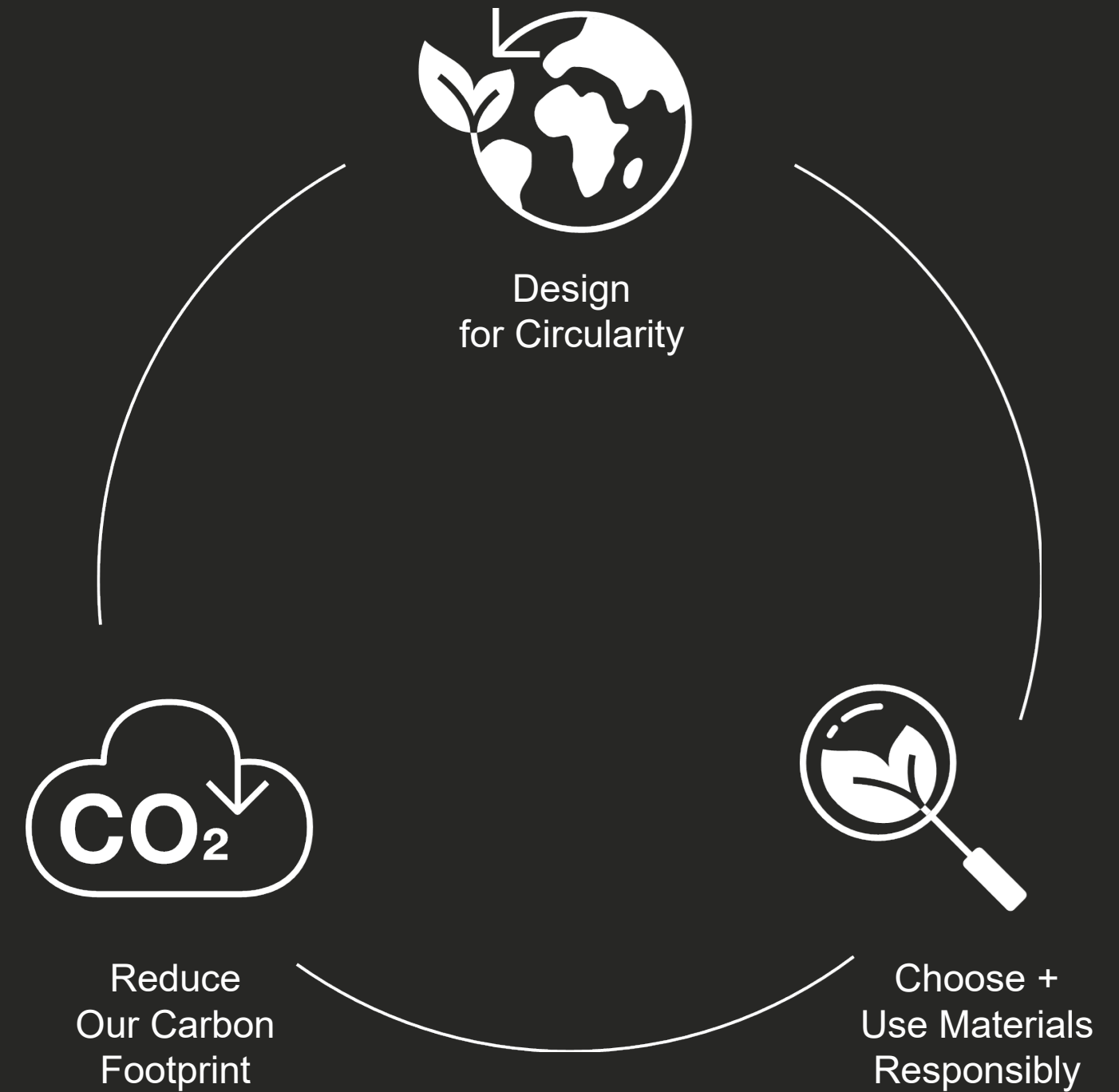

# Product Sustainability Stories



## MIGRATION DESKING COLLECTION

Migration Intro, Migration Pro, & Migration Pro with Boost are now offered with FSC-certification, ensuring the wood originates from sustainable forests protected from clear-cutting and deforestation.



## OCULAR COLLECTION

Most of the Ocular collection has a high level of product ingredient disclosure.



## Everwall™

Everwall is a modular, prefabricated wall system designed with the principles of reducing waste on site, reusing materials and recyclability.



## CAFÉ LEATHER

Café leather is a by-product of the food industry, diverting hides from entering landfill. It is finished without use of solvents or lead. It is produced in a facility which is powered by 100% green electric supply and green natural gas.



## CARBON NEUTRAL COLLECTION

Steelcase Karman, Steelcase Series 2, and Gesture are all available with a CarbonNeutral® product certification option.

# Product Sustainability Stories



## STEELCASE KARMAN

A lighter impact on the planet, Steelcase Karman uses less materials and the least number of components necessary. Weighing only 29 pounds, it's one of the lightest work chairs in the industry.



## COALESSE ENSEMBLE LOUNGE SYSTEM

Coalesse Ensemble supports circular practices through lounge modules on an easy-to-scale rail system and freestanding screens that have zippers allowing for easy assembly and disassembly — enabling future reconfigurability and reuse.



## FLEX PRIVACY WRAP

Using knit to fit, zero-waste technology with less energy, the Privacy Wrap textile is perfectly engineered to fit the unique curves and contours of the screens, eliminating material waste and increasing recyclability.



## ANSWER PANEL SYSTEMS

Answer's durability and frame construction allows for reconfiguration, reuse and an extended useful life now with more planet friendly enhancements including reduction in packaging and using reclaimed paint.

**Steelcase®**